

GENERAL CHARACTERISTICS

Instruments operate by a spring-supported paddle with magnetic triggering of a micro switch.

- * good repeatability
- * low pressure loss
- * dirt resistant
- * hermetic separation of electrical and hydraulic components
- * high switch capability
- * easy adjustment of switch

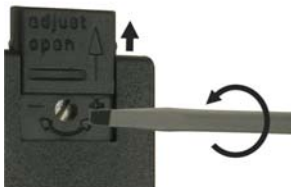

Solder fitting DN 10-40 copper



UM3K-032TC295

TECHNICAL DATA

	DN	Type	PN bar	Qmax. recom. l/min H ₂ O	adjustable range l/min H ₂ O	d mm	H mm	L mm	weight kg
copper	10	UM3K-010TC060	16	10	4.5 - 6	12	84	36	0.30
	12	UM3K-012TC105	16	14	7.5 - 10.5	15	84	40	0.30
	16	UM3K-016TC140	16	24	12 - 14	18	86	44	0.30
	20	UM3K-020TC210	16	40	16.5 - 21	22	86	50	0.30
	25	UM3K-025TC200	16	60	16 - 20	28	92	56	0.35
	32	UM3K-032TC295	16	100	24 - 29.5	35	92	64	0.35
	40	UM3K-040TC475	16	150	37 - 47.5	42	100	74	0.40

Adjustable range is indicated for horizontally decreasing flow.

tolerance	±15% of full scale
media temperature	max. 110°C
average pressure loss	0.01bar at Qmax.
hysteresis	depending on switch value minimum 0.7 l/min.

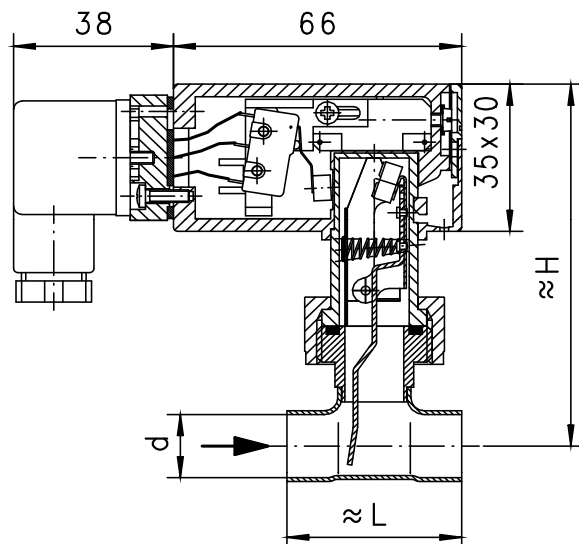

MATERIAL

housing	copper / brass Ms58
body	brass Ms58 nickel plated
paddle	stainless steel 1.4301 ; 1.4571
spring	stainless steel 1.4310
magnet	oxyd 300
seal	NBR

ELECTRICAL DATA

micro switch - wiring 0.371 change over
250 V AC 5 A
plug DIN 43650-A
protection class 2
protection class IP 65

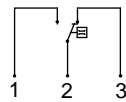

OBASIC
Programme options

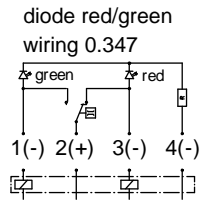
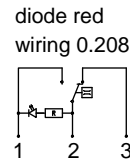
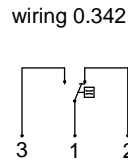

MOUNTING POSITION

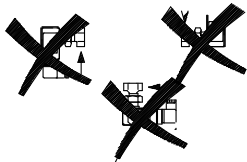

Installation position may influence switch value.

METERING SUBSTANCES



water



gas/air



oil

NOMENCLATURE

For combinations see table "technical data"

UM3K-	010	T	C	060		basic type specification
	010				●	DN 10 - Ø12
	012				●	DN 12 - Ø15
	016				●	DN 16 - Ø18
	020				●	DN 20 - Ø22
	025				●	DN 25 - Ø28
	032				●	DN 32 - Ø35
	040				●	DN 40 - Ø42
		T			●	solder fitting
			C		●	copper design
				060	●	4.5 - 6 l/min
				105	●	7.5 - 10.5 l/min
				140	●	12 - 14 l/min
				200	●	16 - 20 l/min
				210	●	16.5 - 21 l/min
				295	●	24 - 29.5 l/min
				475	●	37 - 47.5 l/min
Programme option BASIC					○	wiring 0.208 - diode red integrated in plug DIN 43650-A wiring 0.347 - diode red/green integrated in plug DIN 43650-A wiring 0.342 gold-plated micro switch 125 V AC / 30 V DC / 100mA
Special option VARIO					□	setting / adjustable ranges for oil or gas contact for locking plug M12x1, 4-pole minimal flow range

IMPORTANT FOR YOUR ORDER

- Please indicate flow direction, metering substance and adjustable range with your order.
- With viscous liquids please indicate viscosity, temperature and metering substance (adjustable range on request)
- With gaseous media indicate pressure (relative or absolute), temperature and metering substance (adjustable range on request)

All technical changes reserved

●BASIC Standard ○BASIC Programme option □VARIO Special option ⊕ PLUS Accessories

~~X~~ not recommendable