



# MULTIDRIVE 3PH from 35A to 2700A

Universal 3 Phase Thyristor Unit



## GENERAL DESCRIPTION

- MULTIDRIVE is a Full digital and universal Thyristor unit based on a very powerful dedicated micro configurable via serial communication port for all inputs, firing modes, control modes and loads types.
- Suitable to drive resistive, inductive, transformer and complex loads requiring current limit and power control mode.
- Frontal Key Pad standard to configure all the internal functions and parameters.
- Four Analog output configurable
- Six Digital input
- Four relay output
- Universal Input signal with automatic zero/span calibration.
- Universal Firing modes, customer configurable via Key Pad or communication port as Burst Firing and Phase Angle.
- Universal Feed back modes
- Soft Start can be used in addition to Burst Firing and Phase Angle.
- Unbalanced load and Heater Break Alarm.
- RS 485 port. Modbus protocol
- Comply with EMC and \*
- IP20 Protection

## TECHNICAL SPECIFICATION

<b>Operating Temperature</b>	0+40°C over this temperature see derating curve
<b>Voltage Power supply</b>	480V standard, 600V or 690V on request
<b>Auxiliary Voltage Supply</b>	90÷265V; 20VA power consumption. Fan voltage supply: 230V ±15% as a standard and 110V on request.
<b>Analog Input 1</b>	Main reference, 4÷20mA, 0÷10V, 10KPOT, RS485 port
<b>Analog Input 2</b>	Secondary reference, 0÷10V, 10KPot
<b>Analog Input 3</b>	External Current Limit Set, via analog input 0-10V or KPOT
<b>Analog Output</b>	Four Analog output 0÷10V, (0÷20mA or 4÷20mA are as an option), to retransmitted One of this Value, Voltage or Power and current for each Phase
<b>Digital Input</b>	Six optoisolated digital output (12/24Vdc), for START, STOP, ENABLE, CALIBRATION, RESET ALARM and EXTERNAL ALARM
<b>Relay Output</b>	Three configurable relay output and one critical alarm
<b>Universal Firing</b>	One of these firing modes can be configured Burst Firing BF, Single Cycles SC, Soft Start + Burst Firing; Soft Start + Phase Angle S+PA Delayed Triggering
<b>Soft Start</b>	Digital adjustable ramp rate can be used in up or/end down mode
<b>Control Mode</b>	Voltage (V), Power (VxI) and External feedback
<b>Heater Break Alarm</b>	Circuit microprocessor based to diagnose partial or total load failure and short circuit on Thyristors
<b>Unbalanced load</b>	This protection allow to have Multidrive working up to 20% of unbalance on one phase
<b>Communication</b>	RS485 Port. Modbus communication protocol 9600 or 19200 bauds
<b>Thermal protection</b>	Available on forced ventilated units

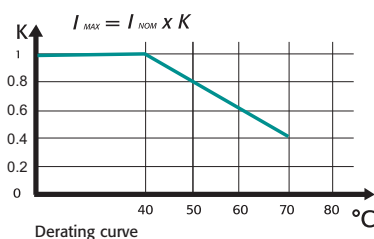

\* cUL approval up to 500A included

## HEATER BREAK ALARM (HB)

### ON FRONT CABINET



The Heater Break circuit diagnostic partial or total load failure. It reads load resistance with an internal voltage transducer and current transformer to calculate the resistance value  $V/I$  circuit is compensated for voltage fluctuation,infact a voltage variation has no influence on resistance value because  $V/I$  ratio remain constant.

On this unit is possible to set the nominal resistance value and the alarm sensitivity.

HB alarm in addition diagnostic the thyristor in short circuit

A normally open contact gives the alarm condition and an indication of the alarm type appears on display.

## BURST FIRING

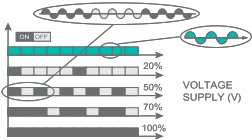

This firing is performed digitally within the thyristor unit at zero volts, producing no EMC interference. Analogue input is necessary for BF and the number of complete cycles must be specified for 50% power demand. This value can be between 1 and 255 complete cycles, determining the speed of firing. When 1 is specified, the firing mode becomes Single Cycle (SC).

## PHASE ANGLE PA

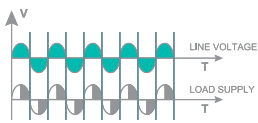

PA controls the power to the load by allowing the thyristor to conduct for part of the AC supply cycle only. The morepower required, the more the conduction angle is advanced until virtually the whole cycle is conducting for 100% power. The load power can be adjusted from 0 to 100% as a function of the analogue input signal, normally determined by a temperature controller or potentiometer, PA is normally used with inductive loads.

## DELAYED TRIGGERING DT

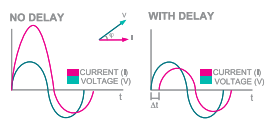

Used to switch the primary coil of transformers when coupled with normal resistive loads (not cold resistance) on the secondary, DT prevents the inrush current when zero voltage (ON-OFF) is used to switch the primary. The thyristor unit switches OFF when the load voltage is negative and switches ON only when positive with a pre-set delay for the first half cycle.

## CD EASY



This is a memory support tool that can be used by maintenance personnel on shop floor.

The user can copy the configuration of one unit and paste it into another. CD EASY is very simple with one push button to upload the configuration (Read and another to down load the stored configuration (Write)

This tool can be used with our Remote service to mail the working configuration via internet.

## CD-KP



The CD-KP is designed mounted on front cabinet and to be connected with all cd automation's Thyristor units via RS485. On front unit is possible to read parameters, power, current, reference and alarms. One of these variables can be selected and retransmitted via an isolated output (4-20mA or 0-10V) On front unit is available a connector to communicate with PC. In addition are available Local/Remote, up and down and function command.

## FIELD BUS MODULE



CD-RS Used to convert RS232 to RS422

TU-RS485-PDP Used to convert RS485 Modbus to Profibus DP

TU-RS485-DNE Used to convert RS485 Modbus to Devicenet

TU-RS485-ETH Used to convert RS485 Modbus to Ethernet

TU-RS485-CAN Used to convert RS485 Modbus to CAN

For more informations see "Field Bus Module" Bulletin

## POWER SCALING

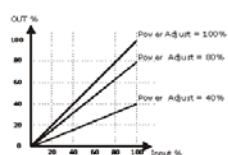

It's a scaling factor of the input command signal and limit the output of Thyristor unit. This parameter can be adjusted from 1 to 99% via RS485 or by the front of the unit If this parameter is setted at 50% and the input signal is 100% the output become 50% This feature is very useful to reduce the power when a zone has been oversized or when a temperature controller gives same reference to more unit along a furnace.

Imagine 3 zones with left and right one close to the door where in a continuous furnace the material come into and flow out.The profile of temperature along furnace is higher in central zone because there is less dispersion but if we scale its input we can have a flat profile.

## APPLICATIONS AND FOCUS ON:

- Infrared lamp.
- Autoclaves.
- Furnaces.
- Chemical
- Petrochemical
- Climatic chambers
- Pharmaceutical

# Wiring connection MULTIDRIVE 3PH from 35A up to 2700A

## MULTIDRIVE 3PH

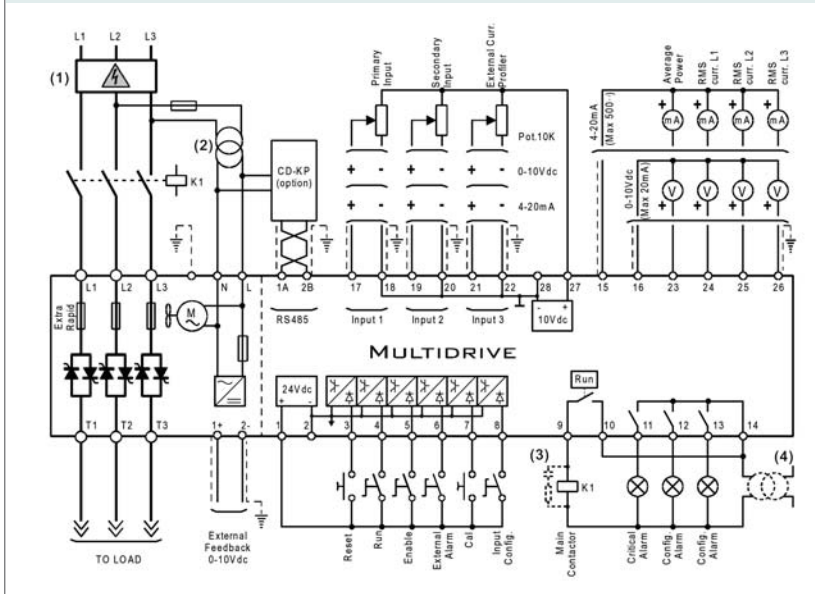

## NOTE

- (1) • The user installation must be protecting by electromagnetic circuit breaker or by fuse isolator.
- (2) • Use an appropriate external transformer based on the voltage supply of the electronic board (see the identification label)
- (3) • The coil contactor, the relays and other inductive loads must be equipped with opportune RC filter.
- (4) • Before give the Start command supply the auxiliary voltage

## LOAD TYPE

Three phase transformer

Cold Resistance  
Molibdenum, Tungstenum  
KantalSuper Platinum,  
Quartz lamp infrared short  
waveform  
Silicon carbide elements

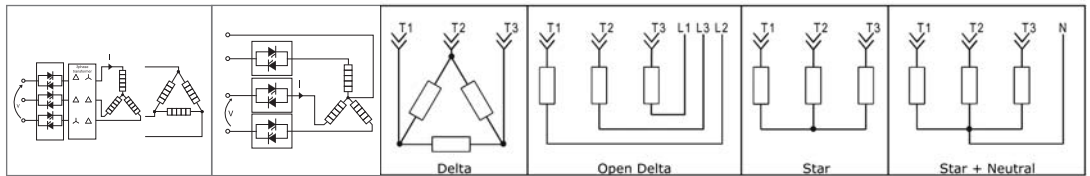

## DIMENSION AND FIXING HOLES

<p><b>S13</b> W 262 mm. - H 440 mm. - D 270 mm. - kg. 18 <b>25A ÷ 225A</b></p>	<p><b>S14</b> W 262 mm. - H 520 mm. - D 270 mm. - kg. 22,5 <b>300A ÷ 600A</b></p>	<p><b>S15</b> W 400 mm. - H 520 mm. - D 270 mm. - kg. 43 <b>850A</b></p>
<p><b>S22</b> W 525 mm. - H 580 mm. - D 435 mm. - kg. 56 <b>1000A</b></p> <p><b>S25</b> W 525 mm. - H 780 mm. - D 435 mm. - kg. 77 <b>1400A</b></p> <p><b>S25</b> W 525 mm. - H 780 mm. - D 435 mm. - kg. 77 <b>1500A</b></p>	<p><b>S26</b> W 780 mm. - H 790 mm. - D 533 mm. - kg. 144 <b>1850A</b></p> <p><b>S26</b> W 780 mm. - H 790 mm. - D 533 mm. - kg. 144 <b>2000A</b></p> <p><b>S27</b> W 890 mm. - H 790 mm. - D 518 mm. - kg. 174 <b>2400A</b></p> <p><b>S27</b> W 890 mm. - H 790 mm. - D 518 mm. - kg. 174 <b>2700A</b></p>	

## OUTPUT FEATURES (POWER DEVICE)

Current A	Voltage range (V)	Ripetitive peak reverse voltage (600V) (690V)		Latching current (mAeff)	Max peak one cycle (10msec.)	Leakage current (mAeff)	I2T value for fusing tp=10msec.	Frequency range (Hz)	Power loss I=Inom (W)	Isolation Voltage Vac
35A	330÷690V	1600	1800	450	1000	15	4750	47÷70	126	2500
45A	330÷690V	1600	1800	450	1000	15	4810	47÷70	162	2500
75A	330÷690V	1600	1800	450	1000	15	4810	47÷70	270	2500
100A	330÷690V	1600	1800	450	1540	15	11300	47÷70	360	2500
125A	330÷690V	1600	1800	450	2000	15	19100	47÷70	450	2500
150A	330÷690V	1600	1800	450	2000	15	19100	47÷70	540	2500
255A	330÷690V	1600	1800	300	4800	15	108000	47÷70	810	2500
300A	330÷690V	1600	1800	300	5250	15	128000	47÷70	1080	2500
350A	330÷690V	1600	1800	200	7800	15	300000	47÷70	1260	2500
400A	330÷690V	1600	1800	200	8000	15	306000	47÷70	1440	2500
450A	330÷690V	1600	1800	1000	17800	15	1027000	47÷70	1620	2500
500A	330÷690V	1600	1800	1000	17800	15	1027000	47÷70	1800	2500
600A	330÷690V	1600	1800	1000	17800	15	1027000	47÷70	2160	2500
850A	330÷690V	1600	1800	1000	17800	15	1027000	47÷70	3000	2500
1000A	330÷600V	1600	N.A.	700	12500	300	781000	47÷70	3300	2500
1400A	330÷690V	1600	1800	700	24600	300	3026x1E3	47÷70	4620	1700
1500A	330÷600V	1600	N.A.	700	24600	300	3026x1E3	47÷70	5625	1700
1850A	330÷690V	1600	1800	700	36000	300	6480x1E3	47÷70	6105	2500
2000A	330÷600V	1800	N.A.	700	36000	300	6480x1E3	47÷70	6600	2500
2400A	330÷690V	1800	1800	700	60000	300	180000x1E3	47÷70	8000	2500
2700A	330÷600V	2200	N.A.	700	60000	300	180000x1E3	47÷70	10125	2500

## ORDERING CODES MULTIDRIVE 3PH

	1	2	3	4	5	6	7	8	9	10	11	12	13	14	15	16
<b>MULTIDRIVE 3PH</b>	<b>M</b>	<b>3</b>	-	-	-	-	-	-	-	-	-	-	-	-	-	-

Note 1

4, 5, 6 Current	
Description code	Numeric code
35A	0 0 3 5
45A	0 0 4 5
75A	0 0 7 5
100A	0 1 0 0
125A	0 1 2 5
150A	0 1 5 0
225A	0 2 2 5
300A	0 3 0 0
350A	0 3 5 0
400A	0 4 0 0
450A	0 4 5 0
500A	0 5 0 0
600A	0 6 0 0
850A	0 8 5 0
1000A (2)	1 0 0 0
1400A	1 4 0 0
1500A (2)	1 5 0 0
1850A	1 8 5 0
2000A (2)	2 0 0 0
2400A	2 4 0 0
2700A (2)	2 7 0 0

7 Max Voltage	
Description code	Numeric code
480V	4
600V	6
690V	7

8 Aux. Voltage supply	
Description code	Numeric code
110V	1
230V	2

9 Input	
Description code	Numeric code
SSR	S
0:10V dc	V
4:20mA	A
10KPot	K
RS485	R

10 Firing	
Description code	Numeric code
Zero Crossing ZC	Z
Single Cycle SC	C
Burst Firing BF	B
Soft Start + Burst Firing S+BF	J
Delayed Triggering + Burst Firing DT+BF	D
Phase Angle PA	P
Soft Start + Phase Angle S+PA	E

11 Control Mode	
Description code	Numeric code
Open Loop	0
Voltage Feed Back V	U
Power Feed Back Vxl	W
Current Feed Back I	I
External Feed Back	E

12 Option	
Description code	Numeric code
4:20mA Retransmission Load Current and Control Mode (3)	A
0:10V Retransmission Load Current and Control Mode (3)	V

13 Fan Voltage	
Description code	Numeric code
Fan Voltage equal to Aux. Voltage	3

14 Approvals	
Description code	Numeric code
CE EMC For European Market	0
cUL For American Market up to 500A	L (4)

15 Manual	
Description code	Numeric code
None	0
Italian Manual	1
English Manual	2
German Manual	3
French Manual	4

16 Load type/Connection	
Description code	Numeric code
Resistive Load/ Delta Connection	1
Resistive Load/ Star Connection	2
Resistive Load/ Star Connection + Neutral	7
Transformer Load/ Delta Connection	3
Transformer Load/ Star Connection	4
Transformer Load/Star Connection + Neutral	5
Resistive Load/ Open delta	6

**LEGEND**  
**IF** = Internal Fixed Fuse  
**CT** = Current Transformer  
**HB** = Heater Break Alarm

Note (1): After 16th digit write current and voltage of load inside brackets Ex. (190A-400V). this is to receive the Thyristor unit already tuned from CD Automation

Note (2): Rating not available at 690V

Note (3): In total are available 4 Analog output . One dedicated to control mode and the other 3 for current on phases 1-2-3

Note (4): cUL approval up to 500A included