



GENERAL DESCRIPTION

- REVO CL has been specifically designed to be an Universal Unit
- RS485 Comm. MODBUS Protocol Standard
- Frontal Key Pad to configure the unit and to read V,I and Power
- Configurability via RS485, USB Port and frontal Key Pad
- Microprocessor based electronic circuit fully isolated from power
- Universal input signal: RS485,Pot, Analog and SSR
- Soft Start + Phase Angle and Delayed Triggering Firing,
- Configurable Control Mode: V, I, V² and VxI
- Current Limit Std adjustable from front unit
- Profiling current limit via analog input
- Heater Break alarm to diagnose partial or total load failure and Thyristor Short circuit
- Digital input configurable
- Fixed Fuses Standard
- Current transformer integrated in Fuse Holder
- Comply with EMC, cUL pending
- IP20 Protection
- DIN RAIL mounting

TECHNICAL SPECIFICATION

Voltage power supply	From 24V to 480V Max (Std) or 600V on request		
Voltage Frequency	50 or 60 Hz no setting needed from 47 to 70 Hz		
Nominal Current	60A, 90A, 120A, 150A, 180A, 210A		
Input Signal	Voltage input	0:10Vdc	impedance 15 K ohm;
	Current input	0:20/4:20mA	impedance 100 Ohm;
Digital input	4:30V dc 5 mA Max (On > 4Vdc Off < 1Vdc)		
Firing	Soft Start + Phase Angle, Delay Triggering + Burst Firing,		
Control Mode	Voltage, Current, Square Voltage and Power selectable via frontal Key Pad, and RS485 or via Digital input to transfer from one control mode to another one to establish a control strategy.		
Auxiliary Voltage Supply	90:130Vac	8VA Max	
	170:265Vac	8VA Max	(Standard)
	230:345Vac	8VA Max	
	300:530Vac	8VA Max	(Standard)
	510:690Vac	8VA Max	
Heater Break Alarm	HB alarm setting on front unit or RS485 with possibility to set sensitivity. Relay output 0,5A at 110V		
Mounting	Panel Mounting		
Operating Temperature	40 °C without derating. Over this temperature see below derating curve		
Storage temperature	-25 °C to 70 °C Max		
Altitude	Over 1000 m of altitude reduce the nominal current of 2% for each 100m		
Humidity	From 5 to 95% without condense and ice		

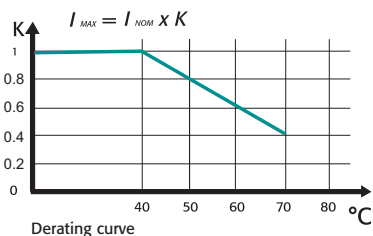

HEATER BREAK ALARM (HB)

ON FRONT CABINET



= FEW MINUTES TO SET AND CALIBRATE ALL THE UNITS

The Heater Break circuit diagnostic partial or total load failure. It reads load resistance with an internal voltage transducer and current transformer to calculate the resistance value V/I circuit is compensated for voltage fluctuation,infact a voltage variation has no influence on resistance value because V/I ratio remain constant.

On this unit is possible to set the nominal resistance value and the alarm sensitivity.

HB alarm in addition diagnostic the thyristor in short circuit

A normally open contact gives the alarm condition and an indication of the alarm type appears on display.

PHASE ANGLE PA

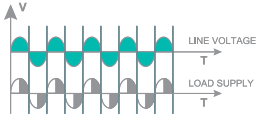

PA controls the power to the load by allowing the thyristor to conduct for part of the AC supply cycle only. The morepower required, the more the conduction angle is advanced until virtually the whole cycle is conducting for 100% power. The load power can be adjusted from 0 to 100% as a function of the analogue input signal, normally determined by a temperature controller or potentiometer, PA is normally used with inductive loads.

DELAYED TRIGGERING DT

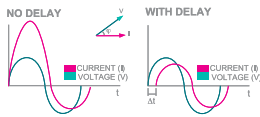

Used to switch the primary coil of transformers when coupled with normal resistive loads (not cold resistance) on the secondary, DT prevents the inrush current when zero voltage (ON-OFF) is used to switch the primary. The thyristor unit switches OFF when the load voltage is negative and switches ON only when positive with a pre-set delay for the first half cycle.

CD EASY



This is a memory support tool that can be used by maintenance personnel on shop floor.

The user can copy the configuration of one unit and paste it into another. CD EASY is very simple with one push button to upload the configuration (Read and another to down load the stored configuration (Write)

This tool can be used with our Remote service to mail the working configuration via internet.

FIELD BUS MODULE



CD-RS Used to convert RS232 to RS422

TU-RS485-PDP Used to convert RS485 Modbus to Profibus DP

TU-RS485-DNE Used to convert RS485 Modbus to Devicenet

TU-RS485-ETH Used to convert RS485 Modbus to Ethernet

TU-RS485-CAN Used to convert RS485 Modbus to CAN

For more informations see "Field Bus Module" bulletin

POWER SCALING

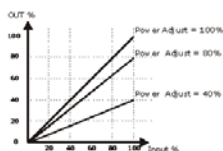

It's a scaling factor of the input command signal and limit the output of Thyristor unit. This parameter can be adjusted from 1 to 99% via RS485 or by the front of the unit If this parameter is setted at 50% and the input signal is 100% the output become 50% This feature is very useful to reduce the power when a zone has been oversized or when a temperature controller gives same reference to more unit along a furnace.

Imagine 3 zones with left and right one close to the doar where in acontinuous furnace the material come into and flow out.The profile of temperature along furnace is higher in central zone because there is less dispersion but if we scale its input we can have a flat profile.

APPLICATIONS AND FOCUS ON:

- Infrared lamp.
- Furnaces.
- Petrochemical
- Dryers
- Pharmaceutical
- Autoclaves.
- Chemical
- Extrusion line.
- Climatic chambers

Wiring connection REVO CL 1PH from 60÷210A

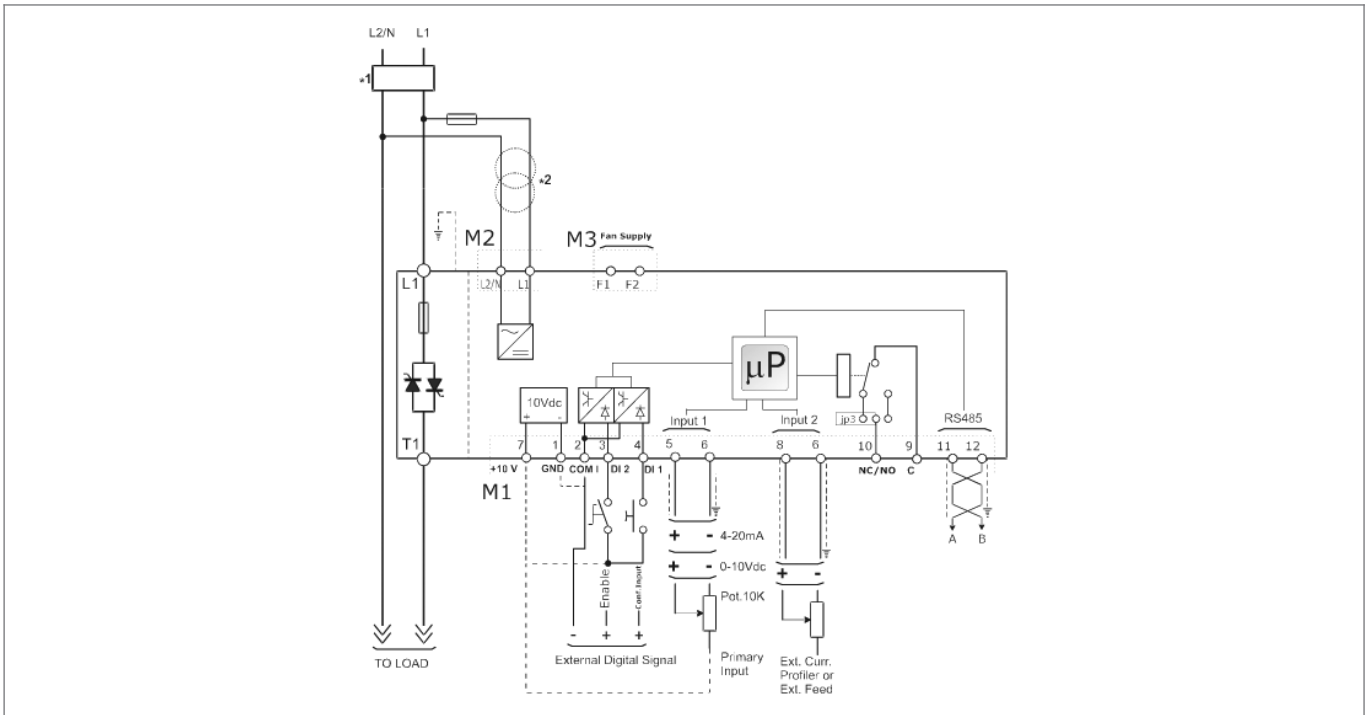

LOAD TYPE

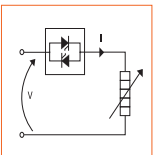

Silicon carbide elements
Molibdenum,
Tungstenum,
kanthalSuper, Platinum
Infrared Lamps

LOAD TYPE

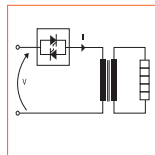

Transformers coupled
with normal
resistance (use DT
Firing Mode)

Transformers coupled
with cold resistances
kanthalSuper (use
Phase Angle + Current
Limit)

NOTE

- The user installation must be protecting by electromagnetic circuit breaker or by fuse isolator. The semiconductor I^t should be 20% less than power controller I^t. Semiconductor fuses are classified for UL as supplementar protection for semiconductor. They are note approved for branch circuit protection.
- The auxiliary voltage supply of the Revo unit must be synchronized with load voltage supply. If the Auxiliary Voltage (written on the identification label) is different from Supply Voltage (to the load), use an external transformer connected as above.

DIMENSION AND FIXING HOLES

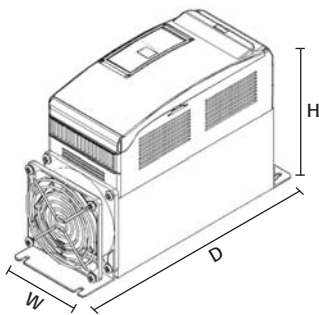

SR15 W 93 mm. - H 273 mm. - D 170 mm. - kg. 3,6

120A - 210A

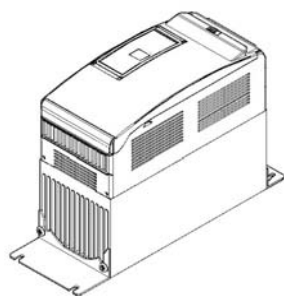
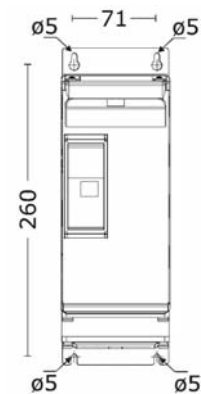

SR15 W 93 mm. - H 269 mm. - D 170 mm. - kg. 3,6

60A - 90A

OUTPUT FEATURES (POWER DEVICE)

Current A	Voltage range (V)	Ripetitive peak reverse voltage (480V) (600V)		Latching current (mAeff)	Max peak one cycle (10msec.)	Leakage current (mAeff)	I2T value for fusing tp=10msec.	Frequency range (Hz)	Power loss I=Inom (W)	Isolation Voltage Vac
60A	24+600V	1200	1600	450	1000	15	4750	47+70	65	2500
90A	24+600V	1200	1600	450	2000	15	19100	47+70	84	2500
120A	24+600V	1200	1600	450	1540	15	11300	47+70	138	2500
150A	24+600V	1200	1600	450	2000	15	19100	47+70	162	2500
180A	24+600V	1200	1600	300	4800	15	108000	47+70	178	2500
210A	24+600V	1200	1600	300	5250	15	128000	47+70	202	2500

Fan Specification

Supply: 230V Standard (need for REVO M > 90A)

Power 16W

Supply: 115V Option (need for REVO M > 90A)

Power 14W

ORDERING CODES REVOCL 1PH

																Note 1
REVO CL 1PH																16
REVO CL 1PH																16
1	2	3	4	5	6	7	8	9	10	11	12	13	14	15	16	
R	C	L	-	-	-	-	-	-	-	-	-	-	-	-	-	
4, 5, 6 Current		8 Aux. Voltage supply		11 Control Mode		14 Approvals										
Description code	Numeric code	Description code	Numeric code	Description code	Numeric code	Description code	Numeric code									
60A	0 6 0	90:130V (2)	1	Open Loop	0	CE EMC For European Market	0									
90A	0 9 0	170:265V (2)	2	Voltage Feed Back V	U	cUL For American Market, Pending	L									
120A	1 2 0	230:345V (2)	3	Power Feed Back VxI	W	15 Manual										
150A	1 5 0	300:530V (2)	5	Voltage Square f/b V ²	Q	Description code	Numeric code									
180A	1 8 0	510:690V (2)	6	Current Feed Back I	I	None	0									
210A	2 1 0	9 Input		12 Fuse & Option		Italian Manual	1									
7 Max Voltage		Description code	Numeric code	Description code	Numeric code	English Manual	2									
Description code	Numeric code	SSR	S	Fixed Fuses +CT	Y	German Manual	3									
480V	4	0:10V dc	V	Fixed Fuses +CT +HB	H	French Manual	4									
600V	6	4:20mA	A	13 Fan Voltage		16 Version										
		10KPot	K	Description code	Numeric code	Description code	Numeric code									
		RS485	R	No Fan ≤ 90A	0	Std with fixed Fuses	1									
		10 Firing		Fan 110V > 90A	1											
		Description code	Numeric code	Fan 220V > 90A Std Version	2											
		Delayed Triggering + Burst Firing DT+BF	D													
		Phase Angle PA	P													
		Soft Start + Phase Angle S+PA	E													

LEGEND
CT = Current Transformer
HB = Heater Break Alarm

Note (1): After 16th digit write current and voltage of load inside brackets Ex. (60A-400V)
Note (2): Load voltage must be included in Selected Auxiliary Voltage Range

