

Product Information

Capacitive Level Transmitter / -Switch Incl. Temperature Control LCC1

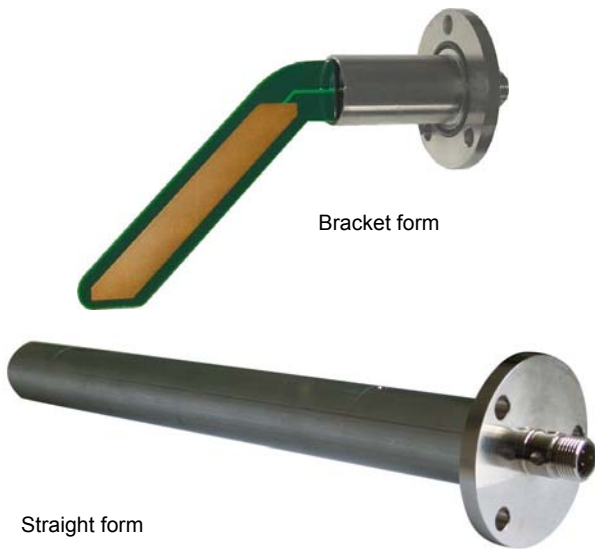

- Developed for oil sumps with highly disturbed level of fill
- No moving parts
- Automatic recognition of different types of oil via reference capacitance
- Temperature control can be integrated
- Switching output (push-pull) and analog output (4..20 mA or 0..10 V)
- Parameters can be programmed in order to achieve best possible adaptation to the application
- Simple installation
- Compact size
- Bracket and straight form

Characteristics

The capacitive LCC1 oil measurer and switch monitors the level of the oil in flat containers with heavily mobile oil surfaces (compressors, engine oil sumps, gearboxes...).

The LCC1 has a reference structure at the end of the sensor, which detects different oils (with different viscosity, at different temperatures) without recalibration.

The programmable filter calculates the running average, and thus reduces the variations in the output signal without negatively affecting the accuracy.

The hysteresis of the switching point can also be adjusted by setting parameters.

The electronics belong to the class of intelligent sensors from HONSBERG, and thus enable the use of the ECI-1 interface (configurator). The USB-compatible interface is used in the manufacture by HONSBERG in order to program the parameters desired by the customer.

Technical data

Sensor	capacitive	
Mechanical connection	3-hole flange or Thread G 1" (Screw flange as accessories)	
Metering range	30 mm (others available on request)	
Measurement accuracy	±1.5 mm	
Repeatability	±1 mm	
Pressure resistance	PN 5 bar	
Long term stability	±1 mm after 100.000 cycles (0..100 % of level)	
Temperature dependency	±0.005 mm/ 1 K	
Medium temperature	-20..+85 °C	
Ambient temperature	-20..+60 °C	
Supply voltage	18..30 V DC (controlled)	
Current consumption at rest	15 mA	
Analog Output	0..10 V or 4..20 mA	
Switching output	push-pull, 100 mA max. resistant to short circuits, reversal polarity protected	
LED (view from 4 sides)	yellow On = oil is within range Flashing = 10 % above min. level Off = oil is below min. level or > temperature limit (max. 95 °C) or defective. Flickering = during programming with magnet. 2 x flashing confirms successful programming.	
Ingress protection	IP 67	
Materials medium-contact	Housing	CW614N nickelled
	O-ring	FKM (EPDM)
	Sensor	FR4, epoxy resin + fibreglass, gold-plated Cu
	Potting	Bectron PK 4342
Materials non-medium-contact	Housing	CW614N nickelled
	O-ring	NBR
	Plug	PA6.6
Weight	0.2 kg	
Conformity	CE	

Product Information

Wiring

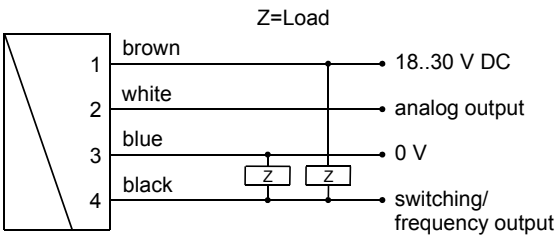

Connection example: PNP NPN

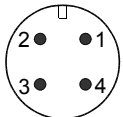

Dimensions

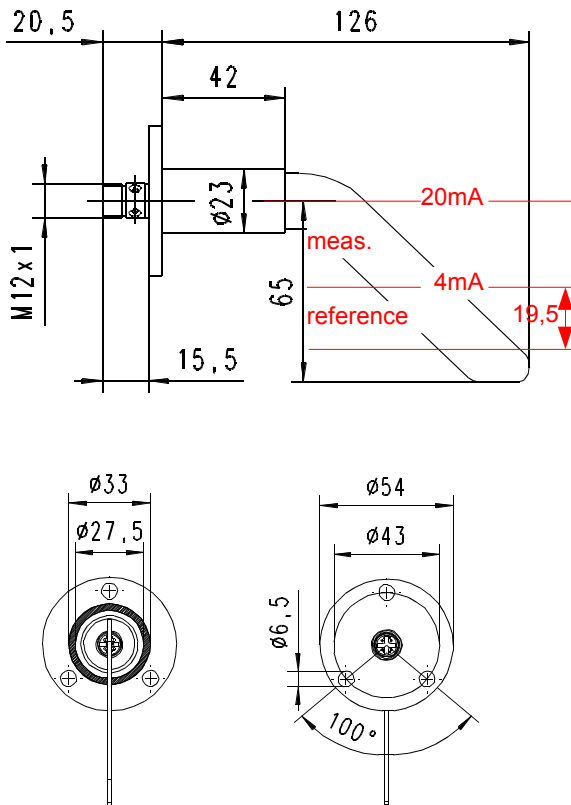

Handling and operation

Before the installation, it must be ensured that the supply voltage corresponds with the data sheet.

The fastening for flange version is by means of 3 x M6 bolts. Refer to "Dimensions" on the drawing for drilling and sealing dimensions.

The flange must be free of contamination and mechanical damage. Bolts should be tightened only enough for the flange to abut against the housing wall.

The threaded version can either be directly screwed in (G1 ") or be attached in a bore (34 mm) by use of two nuts supplied with the

instrument. Alternatively a flange can be screwed onto the thread, which can also be customized.

A magnet clip is used for programming the switching point - if this is desired - or for programming an offset to the start or full scales. Equally, the analog full scale may alternatively be programmed with the clip. The clip can be inserted onto the plug connection or can be removed as a key.

The location to which to apply the clip for one second is marked on the nameplate.



If the programmable switching point is desired:

- Set the level to the switching value or to the value from which the offset was desired.
- Hold the magnet against the marking
- LED flickers
- Remove the magnet from the marking. Two LED pulses mark the end of successful programming.

With a minimum-switch, falling below the limit value causes a switchover to the alarm state. Return to the normal state occurs when the limit value plus the set hysteresis is once more exceeded.

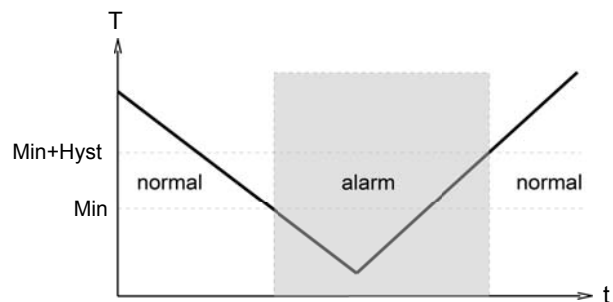

With a maximum-switch, exceeding the limit value causes a switchover to the alarm state. Return to the normal state occurs when the measured value once more falls below the limit value minus the set hysteresis.

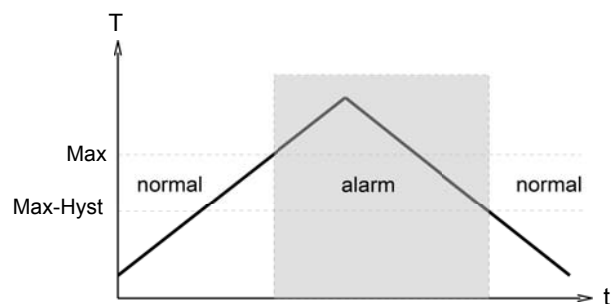

Product Information

A changeover delay time (t_{DS}) can be applied to the switch in the alarm state. Equally, one switch-back delay time (t_{DR}) of several can be applied to switching back to the normal state.

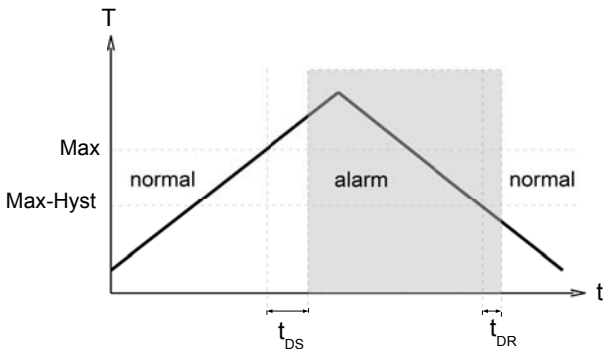

In the normal state the integrated LED is on, in the alarm state it is off, and this corresponds to its status when there is no supply voltage.

In the non-inverted (standard) model, while in the normal state the switching output is at the level of the supply voltage; in the alarm state it is at 0 V, so that a wire break would also display as an alarm state at the signal receiver. Optionally, an inverted switching output can also be provided, i.e. in the normal state the output is at 0 V, and in the alarm state it is at the level of the supply voltage.

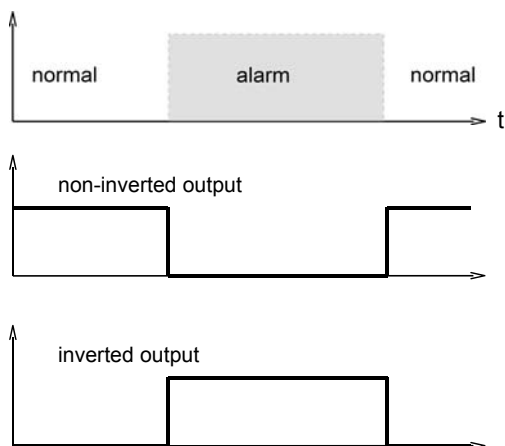

A Power-On-Delay function (ordered as a separate option) makes it possible to maintain the switching output in the normal state for a defined period after application of the supply voltage.

Ordering code

LCC1 - 1. 2. 3. 4. 5. 6. 7. 8. 9. 10. 11.

○=Option

1. Form	
A	Bracket form (side mounting)
B	<input type="checkbox"/> Straight form (installation from above)
2. Connection	
G	Flange
A	Screw-in thread
3. Pipe	
S	Protection tube
4. Installation length	
126	126 mm (only with installation height 56)
200	200 mm (only with installation height 00)
xxx	Weitere auf Anfrage
5. Installation height	
65	65 mm (Form A)
00	0 mm (Form B)
xx	others on request
6. Seal	
V	FKM
7. Output signal	
I	current output 4..20 mA
U	voltage output 0..10 V
8. Switching function	
L	minimum-switch
H	maximum-switch
9. Programming	
N	cannot be programmed (no teaching)
P	<input type="checkbox"/> programmable (teaching possible)
10. Switching output level	
O	standard
I	inverted
11. Electrical connection	
S	for round plug connector M12x1, 4-pole

Product Information

Options

Special range for analog output: mm
<= Metering range (Standard=Metering range)

Special range for frequency output: mm
<= Metering range (Standard=Metering range)

End frequency (max. 2000 Hz) Hz
(Standard = 1000 Hz)

Switching delay , s
(from Normal to Alarm)

Switchback delay , s
(from Alarm to Normal)

Power-On delay s
(After connecting the supply, time during which
the switching output is not activated)

Switching output hard coded %
(from the end value)

Special hysteresis (standard = 2 % EW) %
Temperature monitoring max. 100 °C °C
(Standard = 90 °C)

Protective tube (only for straight sensors) yes

If the field is not completed, the standard setting is selected automatically.

Accessories

- Cable/round plug connector (KB...) see additional information "Accessories"
- Device configurator ECI-1
- Screw flange